



U-Values  
as low as  
**1.4**

# Garage

# Door

price list



Style, Quality  
& Great Value



JUNE 2026



Classic Steel Up & Over	Page 3
Classic Steel Side Hinged	Page 4
Pro Side Hinged	Page 5
Pro 20 Side Hinged	Page 6
Pro Therma Side Hinged	Page 7
Pro, Pro20 & Pro Therma Window Glazing Options	Page 8
Product Guarantees	Page 9
Technical	Page 10

This price list covers the complete range of Fort Doors garage doors, options and accessories. Prices shown exclude VAT and delivery.

#### GENERAL NOTES:

##### Delivery to site POA.

- Multiple doors and remote locations POA.
- All illustrations represent a 2134mm wide X 2134mm high door (7'0" x 7'0") and all sizes are listed width x height.
- Retractable up and over doors are supplied with MAXIPLUS retractable operating gear.
- Frame sizes do not include any fitting tolerances - this must be allowed for if required.
- The position of lock handles may vary dependent on door size.
- Side hinged doors are available as 50:50 opening or 1/3 : 2/3 opening.
- The door order size code should be used for internal dimensions of a timber frame. The size code has traditionally been used to order doors. This may not be the actual door size.

# Classic Steel Up & Over

## STANDARD SIZES

### STYLES

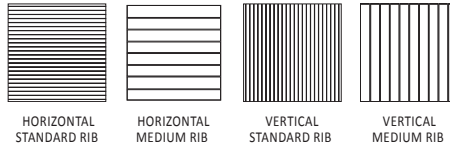

Width x Height (mm x mm)		CANOPY FRAMED - ADD £70 FOR TRACKED GEAR						
		OVERALL WIDTH						
		1900	2150	2250	2300	2400	2600	2750
OVERALL HEIGHT	Up to 2184mm	910	920	941	1014	1144	1472	1591
	White, Black, Anthracite Standard Colour Options	1085	1095	1116	1189	1319	1646	1766

Sizes and prices include frame

## STANDARD SIZES

### STYLES

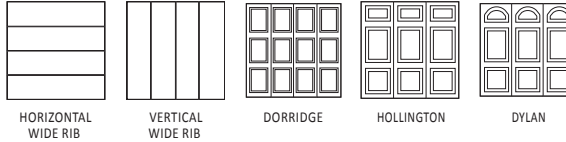

Width x Height (mm x mm)		CANOPY FRAMED - ADD £70 FOR TRACKED GEAR						
		OVERALL WIDTH						
		1900	2150	2250	2300	2400	2600	2750
OVERALL HEIGHT	Up to 2184mm	1201	1232	1248	1201	1279	1352	-
	White, Black, Anthracite Standard Colour Options	1376	1407	1423	1376	1454	1527	-

Sizes and prices include frame

## STANDARD SIZES

### STYLES

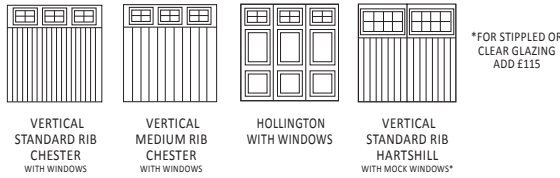

Width x Height (mm x mm)		CANOPY FRAMED - ADD £70 FOR TRACKED GEAR						
		OVERALL WIDTH						
		1900	2150	2250	2300	2400	2600	2750
OVERALL HEIGHT	Up to 2184mm	1503	1508	1518	1555	1680	1706	-
	White, Black, Anthracite Standard Colour Options	1678	1683	1693	1730	1854	1880	-

Sizes and prices include frame

### WINDOWS

- With plastic Perspex: up to 8ft = 3 windows  
Please enquire about other sizes.
- Windows styles: Plain, Stockton Cross or Waterford
- Windows glazing: Stippled, Clear or Black Mock
- Window Inserts - White as standard
- Matching window inserts - FOC

### HANDLE

- Black Die Cast Handle add £45

### 4-POINT LOCKING

- Add £75

### UNFRAMED DOORS

- Canopy unframed doors -£50 off list
- Tracked unframed doors N/A
- All tracked doors will be supplied with a steel frame

### AUTOMATION

- Automation for all Retractable Doors:
- Aperto L £500
- Extra transmitters £115

### COLOURS FOC - White RAL 9016, Black RAL 9005, Anthracite Grey RAL 7016



RAL colours: price on application

### Minimums & Maximums

		HORIZONTAL STANDARD, MEDIUM & WIDE RIB	
C	Min Width	1676	
R	Min Width	1524	
C	Max Width	2438	
R	Max Width	2438	
C	Min Height	1524	
R	Min Height	1879	
C	Max Height	2134	
R	Max Height	2134	

		VERTICAL STANDARD & MEDIUM RIB	
C	Min Width	1676	
R	Min Width	1524	
C	Max Width	2744	
R	Max Width	3048	
C	Min Height	1524	
R	Min Height	1879	
C	Max Height	2134	
R	Max Height	2134	

		VERTICAL WIDE RIB	
C	Min Width	1676	
R	Min Width	1524	
C	Max Width	2438	
R	Max Width	2438	
C	Min Height	1524	
R	Min Height	1879	
C	Max Height	2134	
R	Max Height	2134	

		DORRIDGE	
C	Min width	2083	
R	Min width	2083	
C	Max width	2286	
R	Max width	2286	
C	Min Height	1905	
R	Min Height	1905	
C	Max Height	2134	
R	Max Height	2134	

		HARTSHILL	
C	Min Width	1981	
R	Min Width	1981	
C	Max Width	2438	
R	Max Width	2438	
C	Min Height	1829	
R	Min Height	1879	
C	Max Height	2134	
R	Max Height	2134	

		CHESTER	
C	Min Width	1829	
R	Min Width	1829	
C	Max Width	2438	
R	Max Width	2438	
C	Min Height	1600	
R	Min Height	1879	
C	Max Height	2134	
R	Max Height	2134	

		HOLLINGTON & DYLAN	
C	Min Width	1900	
T	Min Width	1900	
C	Max Width	2438	
T	Max Width	2438	
C	Min Height	1905	
T	Min Height	1905	
C	Max Height	2134	
T	Max Height	2134	

† NB: Minimum and maximum sizes above are the internal frame - add 50mm to both sides and 50mm to the height for the over frame size.

# Classic Steel Side Hinged

Overall size includes frame  
Made to Measure - Next size up

## STYLES

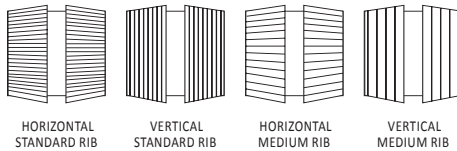

### STANDARD SIZES

Width x Height (mm x mm)		SIDE HINGED							
		OVERALL WIDTH							
		1900	2150	2250	2300	2400	2600	2750	
OVERALL HEIGHT	Up to 2040mm	White, Black, Anthracite	1077	1213	1268	1294	1349	1457	1540
		Standard Colour Options	1222	1377	1439	1470	1531	1655	1748
OVERALL HEIGHT	Up to 2184mm	White, Black, Anthracite	1154	1299	1357	1387	1444	1562	1649
		Standard Colour Options	1308	1475	1542	1574	1640	1774	1874
OVERALL HEIGHT	Up to 2340mm	White, Black, Anthracite	1230	1384	1447	1479	1541	1665	1760
		Standard Colour Options	1395	1572	1643	1679	1751	1892	1998

## STYLES

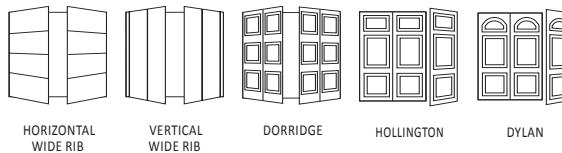

### STANDARD SIZES

Width x Height (mm x mm)		SIDE HINGED							
		OVERALL WIDTH							
		1900	2150	2250	2300	2400	2600	2750	
OVERALL HEIGHT	Up to 2040mm	White, Black, Anthracite	1180	1331	1390	1420	1480	1598	1690
		Standard Colour Options	1264	1423	1488	1520	1584	1712	1787
OVERALL HEIGHT	Up to 2184mm	White, Black, Anthracite	1265	1424	1489	1521	1585	1713	1810
		Standard Colour Options	1353	1525	1593	1624	1697	1835	1937
OVERALL HEIGHT	Up to 2340mm	White, Black, Anthracite	1348	1519	1587	1623	1691	1828	1930
		Standard Colour Options	1442	1627	1700	1737	1810	1957	2067

## PERSONNEL DOORS

## STYLES

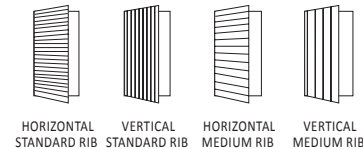

### STANDARD SIZES

Width x Height (mm x mm)		PERSONNEL		
		OVERALL WIDTH		
		800	1000	
OVERALL HEIGHT	Up to 2040mm	White, Black, Anthracite	552	678
		Standard Colour Options	569	699
OVERALL HEIGHT	Up to 2184mm	White, Black, Anthracite	586	725
		Standard Colour Options	606	747
OVERALL HEIGHT	Up to 2340mm	White, Black, Anthracite	626	771
		Standard Colour Options	646	796

### Minimums & Maximums Side Hinged

HORIZONTAL STANDARD, MEDIUM & WIDE RIB		
1/3 2/3	Min Width	1400
50/50	Min Width	1400
1/3 2/3	Max Width	2438
50/50	Max Width	2650
1/3 2/3	Min Height	1500
50/50	Min Height	1500
1/3 2/3	Max Height	2286
50/50	Max Height	2286

VERTICAL STANDARD, MED & WIDE RIB		
1/3 2/3	Min Width	1400
50/50	Min Width	1400
1/3 2/3	Max Width	2438
50/50	Max Width	2650
1/3 2/3	Min Height	1500
50/50	Min Height	1500
1/3 2/3	Max Height	2286
50/50	Max Height	2286

DORRIDGE		
50/50 Only	Min width	2083
50/50 Only	Max width	2286
50/50 Only	Min Height	1905
50/50 Only	Max Height	2134

HOLLINGTON & DYLAN		
1/3 2/3 Only	Min width	1829
1/3 2/3 Only	Max width	2438
1/3 2/3 Only	Min Height	1905
1/3 2/3 Only	Max Height	2134

† NB: Minimum and maximum sizes above are the internal frame - add 50mm to both sides and 50mm to the height for the over frame size.

### HANDLE

- Black Die Cast Handle £45

### EXTRAS

- Door Stays £78

### Minimums & Maximums Personnel

HORIZONTAL & VERTICAL STANDARD & MEDIUM RIB	
Min width	400
Max width	1000
Min Height	400
Max Height	2286

† NB: Minimum and maximum sizes above are the internal frame - add 50mm to both sides and 50mm to the height for the over frame size.

### COLOURS FOC - White RAL 9016, Black RAL 9005, Anthracite Grey RAL 7016



# Pro Side Hinged

Overall size includes frame  
Made to Measure - Next size up

## STYLES



PERSONNEL  
(ALL STYLES RIGHT)



HORIZONTAL  
STANDARD RIB

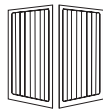

VERTICAL  
STANDARD RIB



HORIZONTAL  
MEDIUM RIB



VERTICAL  
MEDIUM RIB



HORIZONTAL  
WIDE RIB

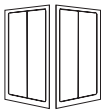

VERTICAL  
WIDE RIB

## STANDARD SIZES

Width x Height (mm x mm)		OVERALL WIDTH	PERSONNEL			SIDE HINGED						
			800	1000	1320	1900	2150	2250	2300	2400	2600	2750
OVERALL HEIGHT	Up to 2040mm	White, Black, Anthracite	614	708	921	1294	1464	1546	1567	1634	1771	1872
		Standard Colour Options	650	780	1025	1442	1632	1709	1746	1822	1974	2088
OVERALL HEIGHT	Up to 2184mm	White, Black, Anthracite	666	754	988	1388	1572	1644	1681	1753	1901	2010
		Standard Colour Options	695	832	1092	1549	1752	1834	1875	1956	2120	2241
OVERALL HEIGHT	Up to 2340mm	White, Black, Anthracite	676	806	1056	1485	1680	1757	1797	1875	2031	2148
		Standard Colour Options	739	895	1181	1655	1874	1959	2004	2090	2265	2396

## STYLES



PERSONNEL  
(ALL STYLES RIGHT)



HORIZONTAL  
WIDE RIB  
WESTHILL  
WITH PULL HANDLES



VERTICAL  
MEDIUM RIB  
WESTHILL  
WITH PULL HANDLES

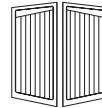

ALTON



HOLLINGTON



DYLAN

## STANDARD SIZES

Width x Height (mm x mm)		OVERALL WIDTH	PERSONNEL			SIDE HINGED						
			800	1000	1320	1900	2150	2250	2300	2400	2600	2750
OVERALL HEIGHT	Up to 2040mm	White, Black, Anthracite	687	827	1087	1446	1637	1713	1751	1827	1981	2094
		Standard Colour Options	728	905	1196	1596	1805	1889	1932	2015	2183	2309
OVERALL HEIGHT	Up to 2184mm	White, Black, Anthracite	713	890	1170	1553	1757	1840	1880	1962	2125	2247
		Standard Colour Options	780	1066	1274	1713	1938	2027	2073	2163	2345	2480
OVERALL HEIGHT	Up to 2340mm	White, Black, Anthracite	770	947	1243	1659	1878	1965	2009	2096	2271	2402
		Standard Colour Options	822	1077	1352	1831	2071	2168	2216	2311	2505	2649

## STYLES



PERSONNEL  
(HARTSHILL ONLY)



VERTICAL  
STANDARD RIB  
CHESTER  
WITH WINDOWS



VERTICAL  
MEDIUM RIB  
CHESTER  
WITH WINDOWS



VERTICAL  
STANDARD RIB  
HARTSHILL\*  
WITH STIPPLED WINDOWS

\*HARTSHILL ONLY  
AVAILABLE 50/50 SPLIT  
STANDARD RIB VERTICAL

## STANDARD SIZES

Width x Height (mm x mm)		OVERALL WIDTH	PERSONNEL			SIDE HINGED						
			800	1000	1320	1900	2150	2250	2300	2400	2600	2750
OVERALL HEIGHT	Up to 2040mm	White, Black, Anthracite	749	942	1238	1749	1980	2072	2118	2231	2394	2531
		Standard Colour Options	812	1020	1347	1897	2148	2247	2297	2398	2596	2748
OVERALL HEIGHT	Up to 2184mm	White, Black, Anthracite	817	1014	1326	1878	2125	2224	2273	2372	2569	2718
		Standard Colour Options	869	1092	1441	2037	2305	2412	2466	2573	2788	2949
OVERALL HEIGHT	Up to 2340mm	White, Black, Anthracite	858	1077	1415	2007	2270	2375	2429	2535	2746	2903
		Standard Colour Options	947	1170	1540	2176	2463	2578	2636	2750	2979	3151

### Minimums & Maximums Side Hinged

1/3 2/3	Min width	1500
50/50	Min width	1500
1/3 2/3	Max width	2438
50/50	Max width	2650
1/3 2/3	Min Height	1500
50/50	Min Height	1500
1/3 2/3	Max Height	2286
50/50	Max Height	2286

		HOLLINGTON & DYLAN	
1/3 2/3 Only	Min width	2134	
1/3 2/3 Only	Max width	2650	
1/3 2/3 Only	Min Height	1981	
1/3 2/3 Only	Max Height	2134	

### Minimums & Maximums Personnel

Min width	600
Max width	1320
Min Height	1500
Max Height	2286

† NB: Minimum and maximum sizes above are the internal frame - add 50mm to both sides and 50mm to the height for the over frame size.

### WINDOWS

- Windows glazing: Hartshill & Chester - See page 8 for options
- Window Inserts - White, Black, Anthracite - FOC
- Matching window frames/inserts - add £165

### HINGES

- Black as standard
- Colour coded hinges available on request

### HANDLE

- Black Lever Handle as standard
- White FOC
- Chrome FOC

### EXTRAS

- Door Stays £78
- Threshold £155
- Opening in £185
- 3-point locking £300

### COLOURS FOC - White RAL 9016, Black RAL 9005, Anthracite Grey RAL 7016



RAL colours: price on application

Overall size includes frame  
Made to Measure - Next size up

## STYLES

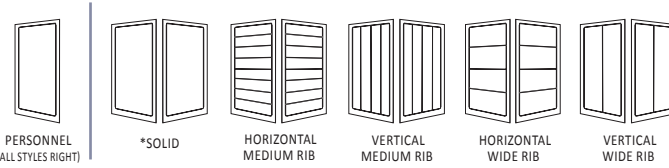

## STANDARD SIZES

Width x Height (mm x mm)		PERSONNEL					SIDE HINGED					
OVERALL WIDTH		800	1000	1320	1900	2150	2250	2300	2400	2600	2750	
OVERALL HEIGHT	Up to 2040mm	White, Grey & Black	779	974	1286	1852	2094	2192	2241	2338	2534	2680
		Standard Colour Options	842	1052	1389	1999	2264	2369	2422	2527	2737	2896
OVERALL HEIGHT	Up to 2184mm	White, Grey & Black	837	1046	1381	1988	2248	2353	2406	2510	2720	2875
		Standard Colour Options	903	1131	1492	2147	2429	2542	2598	2712	2938	3108
OVERALL HEIGHT	Up to 2340mm	White, Grey & Black	894	1116	1474	2124	2403	2233	2476	2683	2905	3074
		Standard Colour Options	966	1208	1594	2294	2595	2717	2759	2812	3139	3321

## STYLES



## STANDARD SIZES

Width x Height (mm x mm)		PERSONNEL					SIDE HINGED					
OVERALL WIDTH		800	1000	1320	1900	2150	2250	2300	2400	2600	2750	
OVERALL HEIGHT	Up to 2040mm	White, Grey & Black	985	1231	1627	2340	2648	2772	2833	2984	3203	3388
		Standard Colour Options	1048	1310	1730	2489	2817	2948	3012	3144	3406	3603
OVERALL HEIGHT	Up to 2184mm	White, Grey & Black	1058	1322	1745	2512	2843	2976	3041	3174	3438	3636
		Standard Colour Options	1125	1408	1857	2672	3024	3044	3805	3375	3656	3867
OVERALL HEIGHT	Up to 2340mm	White, Grey & Black	1131	1413	1864	2685	3038	3179	3250	3391	3674	3886
		Standard Colour Options	1215	1502	1984	2903	3231	3383	3456	3607	3908	4132

TRADITIONAL AVAILABLE IN MID RIB / WIDE RIB HORIZONTAL OR VERTICAL & SOLID PANEL



DOOR STAYS ARE INCLUDED AS STANDARD ON DOUBLE LEAF INSULATED DOORS.

### WINDOWS

- All styles are available with a traditional style double glazed top section which have white inserts as standard (colour matched inserts also available) in stippled or clear glazing. Traditional glazing is only available on 50:50 split doors.
- Additional square port hole windows £145 per window



- Windows glazing: See page 8 for options
- Window Inserts - White, Black, Anthracite - FOC
- Matching window frames/inserts - add £165

### HANDLES

- Chrome as standard
- Black FOC
- White FOC
- Bronze £55
- Gold £55
- Antique Black £55
- Anthracite £55
- Graphite £55
- Satin £55
- Brushed Steel £55
- Chrome Smart Lock £395



### ROLLER BALL LOCKING AND PULL BARS:

- 1200mm Pull Bar £345
- 1600mm Pull Bar £415

### EXTRAS

- 3 Point Locking £300
- Opening IN £185
- 3 Star Anti Snap Lock £95

### Minimums & Maximums Side Hinged

1/3 2/3	Min width	1500
50/50	Min width	1500
1/3 2/3	Max width	2438
50/50	Max width	2650
1/3 2/3	Min Height	1500
50/50	Min Height	1500
1/3 2/3	Max Height	2286
50/50	Max Height	2286

### Minimums & Maximums Personnel

Min width	600
Max width	1320
Min Height	1500
Max Height	2286

† NB: Minimum and maximum sizes above are the internal frame - add 50mm to both sides and 50mm to the height for the over frame size.

### COLOURS FOC - White RAL 9016, Black RAL 9005, Anthracite Grey RAL 7016



RAL colours: price on application

Overall size includes frame  
Made to Measure - Next size up

## STYLES

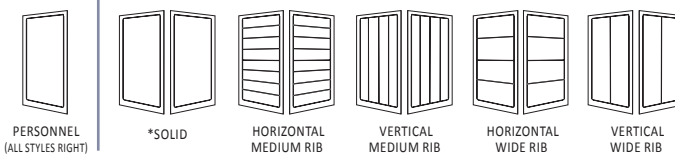

## STANDARD SIZES

Width x Height (mm x mm)		PERSONNEL					SIDE HINGED					
OVERALL WIDTH		800	1000	1320	1900	2150	2250	2300	2400	2600	2750	
OVERALL HEIGHT	Up to 2040mm	All colours	1048	1310	1730	2489	2817	2948	3012	3145	3406	3603
	Up to 2184mm	All colours	1125	1408	1857	2672	3024	3164	3235	3375	3656	3867
	Up to 2340mm	All colours	1203	1502	1984	2855	3231	3383	3457	3607	3908	4132

## STYLES



## STANDARD SIZES

Width x Height (mm x mm)		PERSONNEL					SIDE HINGED					
OVERALL WIDTH		800	1000	1320	1900	2150	2250	2300	2400	2600	2750	
OVERALL HEIGHT	Up to 2040mm	All colours	1158	1446	1910	2749	3111	3288	3328	3472	3762	3980
	Up to 2184mm	All colours	1260	1553	2050	2951	3339	3495	3572	3727	4039	4271
	Up to 2340mm	All colours	1328	1659	2191	3153	3569	3735	3817	3983	4315	4564

TRADITIONAL AVAILABLE IN MID RIB / WIDE RIB HORIZONTAL OR VERTICAL & SOLID PANEL



DOOR STAYS ARE INCLUDED AS STANDARD ON DOUBLE LEAF INSULATED DOORS.

### WINDOWS

- All styles are available with a traditional style double glazed top section which have white inserts as standard (colour matched inserts also available) in stippled or clear glazing. Traditional glazing is only available on 50:50 split doors.
- Additional square port hole windows £145 per window
- Windows glazing: See page 8 for options
- Window Inserts - White, Black, Anthracite - FOC
- Matching window frames/inserts - add £165

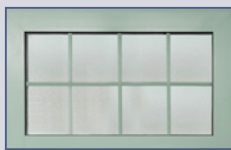

### HANDLES

- Chrome as standard
- Black FOC
- White FOC
- Bronze FOC
- Gold FOC
- Antique Black FOC
- Anthracite FOC
- Graphite FOC
- Satin FOC
- Brushed Steel FOC
- Chrome Smart Lock £395



### ROLLER BALL LOCKING AND PULL BARS:

- 1200mm Pull Bar £345
- 1600mm Pull Bar £415

### EXTRAS

- 3 Point Locking FOC
- Opening IN £185
- 3 Star Anti Snap Lock FOC

### Minimums & Maximums Side Hinged

1/3 2/3	Min width	1500
50/50	Min width	1500
1/3 2/3	Max width	2438
50/50	Max width	2650
1/3 2/3	Min Height	1500
50/50	Min Height	1500
1/3 2/3	Max Height	2286
50/50	Max Height	2286

### Minimums & Maximums Personnel

Min width	600
Max width	1320
Min Height	1500
Max Height	2286

† NB: Minimum and maximum sizes above are the internal frame - add 50mm to both sides and 50mm to the height for the over frame size.

## COLOURS



RAL colours: price on application

# Window Glazing Options

The Pro, Pro 20 and Pro Therma side hinged and personnel doors can also be supplied with a selection of Pilkington patterned glass options. The range is perfectly suited for allowing light into your garage as well as creating your preferred level of privacy.

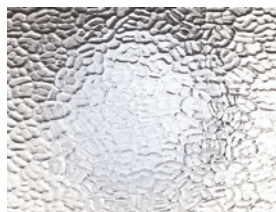

Arctic



Autumn

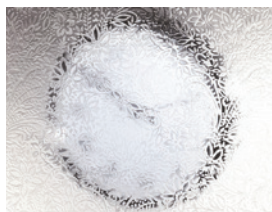

Chantilly

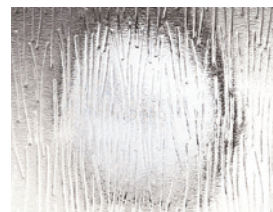

Charcoal Sticks



Contora



Cotswold



Digital



Everglade

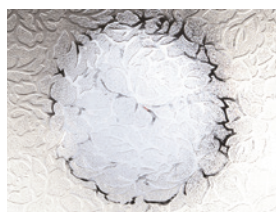

Florielle



Mayflower

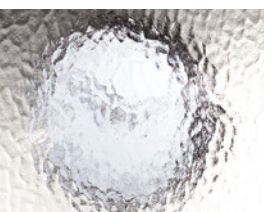

Minster

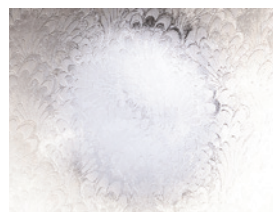

Pelerine



Stippolyte

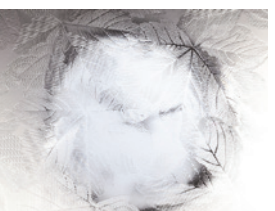

Sycamore



Satin

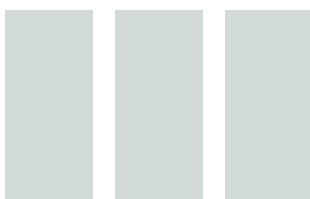

In the unlikely event of a warranty claim, please contact your dealer that installed your garage door and supply them details of the serial number on the side or back of the garage door.

Your dealer will supply further details of the claim along with proof of purchase to the warranty department at Fort Doors.

## Warranty period

A warranty covering the safe and reliable operation of the Fort Doors garage door for a period of 10 years from the date of purchase is given to the original purchaser, this warranty is for help and advice on the safety and reliability of the product and identifying parts and consumables in the event of a failure.

## Product Guarantee

The standard guarantee of 2 years is given to the holder of the product that covers all parts and the panel providing the serial number is readable, intact and in place. Factory applied paint finishes have 2 years on steel doors that have standard colours applied, special non-standard colours are excluded.

The product is given a 2-year warranty for the following item – springs; tracks; rollers; hinges and locking for normal use whereby normal use consists of no more than 5 operations (open/ close) per day. We recommend the product is inspected and serviced annually by a competent engineer from the garage door industry, the warranty for parts replaced by an engineer or for supply only is 6 months or for the remainder of the warranty period. All cables are excluded from the warranty given.

If warranty work is carried out the product guarantee does not extend past the anniversary of installation / supply date.

## Requirements

Warranties are valid in the UK only for European countries contact your dealer.

The product must have been purchased through one of our authorised partners and a serial number and receipt of purchase provided.

The warranty only covers damage to the garage door in the unlikely event of a failure, no surrounding items are covered.

## Performance

During the warranty period we will rectify defects to the Fort product that can be proven to be material or manufacturing faults. At our discretion we will either exchange; repair or reduce the price. We will not accept any costs for dismantling; installation or delivery.

## Warranty exclusions.

Doors must be inspected on delivery and are only to be signed for once you are satisfied with the condition, please do not accept any item you are not satisfied with. You have 48 hours from receipt of the item to inform us of any issues. By installing the garage door, the customer acknowledges and accepts the condition of the door as it stands post-delivery, no claim for damage will be accepted once the item has been installed.

Improper transport; fitting and adjustment.

Repairs by non-qualified or non-competent individuals.

External influences such as fire, water, salt, alkaline solutions, acid, bird droppings or abnormal atmospheric pollution.

The use of non-Fort Doors parts without the approval of the manufacturer.

Damage caused in general use after delivery.

All cables have a limited warranty of 2 years for parts only, cables should be checked regularly and adjusted by a recognised installer, a list of service engineers is available from the Fort customer service department. Failure to inspect, adjust or replace damaged cables early can cause a terminal failure of the product and prevent entry into the garage.

Painted doors give an outstanding finish compared to hand painted doors however they can be scratched or chipped by everyday use, refer to the internal label for care and maintenance of your door, The paint finish is cosmetic and the front panel should be uniform when viewed from 3 meters distance, we offer a 2 year warranty against paint failure, minor blemishes in the finish are inevitable.

The rear of the door will not enjoy such a uniform finish by its nature and will have a different level of coating due to the manufacturing process however this does not affect the performance of the product and all doors are supplied galvanized and Painted or galvanized only giving outstanding external use.

Minor scratches or marks are not covered under the conditions of our warranty and should be repaired immediately to prevent corrosion and deterioration of the panel. Minor surface damage can easily be repaired using touch up sprays or paint sticks without invalidating the warranty.

Touch up paint stick are available upon request.

The rolling or pressing of steel panels during manufacturing may cause distortion in the steel and while every effort is made to keep this to a minimum, Inevitably some distortion will remain, The powder coating process may make this slight distortion more apparent, Especially under certain lighting conditions.

Doors fitted near the coast and inland estuaries are exempt from the paint finish warranty.

## Additional information.

Doors are handmade, consequently, door dimensions will vary slightly. Please allow for a tolerance of  $\pm 3-4$ mm.

It is a fundamental condition of this guarantee that the product has been installed, maintained, cleaned and serviced correctly and is used solely for which it was designed.

Incorrect installation, maintenance and service will invalidate the warranty.

The door must be kept in a clean condition and free from impact damage, any areas of paint damage must be dressed with touch up paint as soon as possible.

We strongly advise that you do not book an installer or remove your existing door until your goods have arrived and have been checked. We are not liable for any installation costs, consequential losses for time, travel costs, costs due to transport damage on arrival or compensation in any way. We require to be notified of any damaged goods within 48 hours of arrival.

# Retractable & Canopy Technical

## FRAMED RETRACTABLE DOORS ALL SIZES

- Frame size** All doors 50mm per side and 50mm cross bar.
- FOW/H** = Frame opening size between the frame inside edges and the threshold to the underside of the frame head from a visible point at the front of the door.
- DTW/H** = Drive through size, the clear opening to allow an object to pass through the space without being impeded by the gearing, seals or leaf. (size does not include handles on manual tracked doors).
- DTW** = Door size less 35mm per side.
- DTH** = Frame opening height less 116mm.
- OAF(W)** = Door and frame size combined.
- OAF(H)** = Door height plus 50mm frame.
- SR** = Side room - only important if frame is fitted behind the brickwork when 100mm per side is required (frame + brackets).
- BR** = 7ft high door 1.850m (from back of frame)  
6'6" high 1.850m (from back of frame) (manual operation).
- HR** = 0mm
- Kick out** = Refers to the out swing of the door - maximum 1200mm.

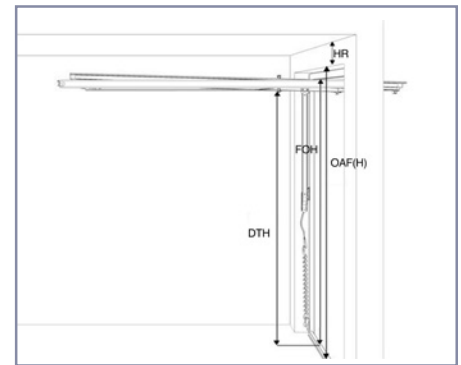
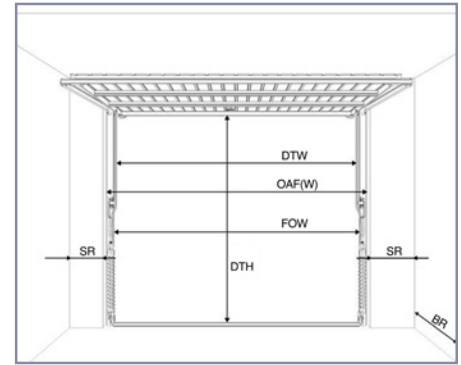

Door Style	Open position	FO-SIZE	DT-WIDTH	DT-HEIGHT
Tracked Single 2020-on	Full open	2134 x 1981	2064	1865

Calculation = FO Width: Less arm width, 35mm per side = 70mm total.  
FO Height: Less slam, less leaf depth, less tolerances = 116mm.

All sizes exclude fitting tolerances and these should be assessed on site depending on the application, a recommendation is 8-10mm per side.

Heights for up and over doors are adjustable depending on the opening position of the door leaf, the drive through can be increased or decreased depending on the final fixing position and the installer should assess the installation as claims after installation will not be accepted.

## FRAMED CANOPY DOORS ALL SIZES

- Frame size** All doors 50mm per side and 50mm cross bar.
- FOW/H** = Frame opening size between the frame inside edges and the threshold to the underside of the frame head from a visible point at the front of the door.
- DTW/H** = Drive through size, the clear opening to allow an object to pass through the space without being impeded by the gearing, seals or leaf. (size does not include handles on manual canopy doors).
- DTW** = Door size less 15mm per side.
- DTH** = Frame opening height less 116mm.
- OAF(W)** = Door and frame size combined.
- OAF(H)** = Door height plus 50mm frame.
- SR** = Side room - only important if frame is fitted behind the brickwork when 100mm per side is required (frame + brackets).
- HR** = 0mm

### Order Height

FOH	KU	KO	BR	
6'4"	1940	55	665	1280
6'6"	1980	55	705	1280
6'10"	2080	55	805	1280
7'	2135	55	860	1280

Door Style	Open position	FO-SIZE	DT-WIDTH	DT-HEIGHT
Canopy Single 2020-on	Full open	2134 x 1981	2104	1865

Calculation = FO Width: Less side seal width, 15mm per side = 30mm total.  
FO Height: Less slam, less leaf depth, less tolerances = 116mm.

All sizes exclude fitting tolerances and these should be assessed on site depending on the application, a recommendation is 8-10mm per side.

Heights for up and over doors are adjustable depending on the opening position of the door leaf, the drive through can be increased or decreased depending on the final fixing position and the installer should assess the installation as claims after installation will not be accepted.

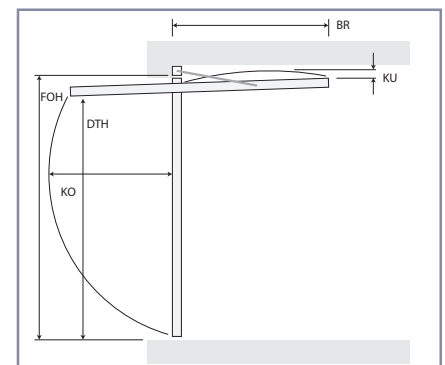
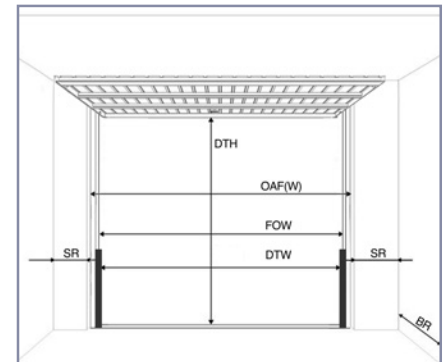

## FRAMED SIDE HINGED DOORS ALL SIZES

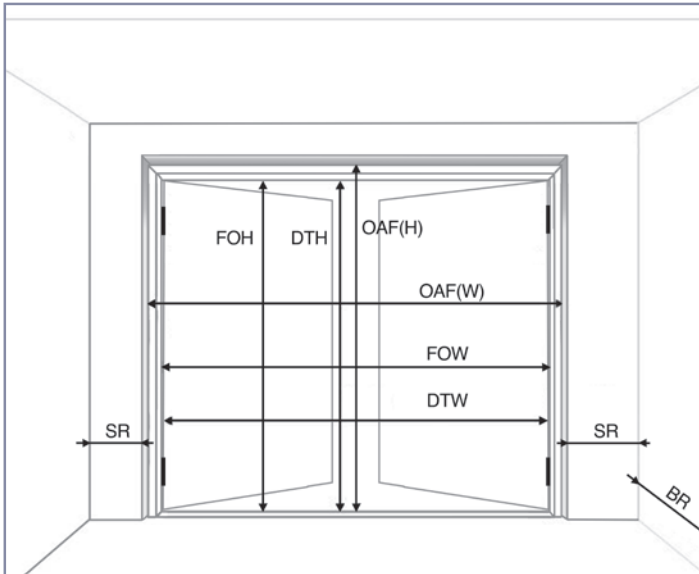

- Frame size** All doors 50mm per side and 50mm cross bar.
- FOW/H** = Frame opening size between the frame inside edges and the threshold to the underside of the frame head from a visible point at the front of the door.
- DTW/H** = Drive through size, the clear opening to allow an object to pass through the space without being impeded by the seals or leaf.
- OAF(W)** = Door and frame size combined.
- OAF(H)** = Door height plus 50mm frame.
- SR** = Side room for Classic side hinged doors - only important if frame is fitted behind the brickwork when 100mm per side is required (frame + brackets). Pro versions require 60mm per side as you can only fit 10mm of the frame behind the opening.
- BR** = Back room - only important if the door is inward opening, as a guide allow half of the OAF(W).

Door Style	Open position	FO-SIZE	DT-WIDTH	DT-HEIGHT
Classic 2025-on	110 degrees	2134 x 1981	2034	1960
PRO 2025-on	110 degrees	2134 x 1981	2034	1965
PRO 20 2025-on	110 degrees	2134 x 1981	2034	1950
PRO Therma 2025-on	110 degrees	2134 x 1981	2070	1930

Calculation = FO Width: Less leaf widths = 100mm total.  
**Classic** FO Height: Less slam strip = 21mm.

Calculation = FO Width: Less leaf widths = 100mm total.  
**PRO** FO Height: Less slam strip = 16mm.

Calculation = FO Width: Less leaf widths = 100mm total.  
**PRO 20** FO Height: Less slam strip 16mm less threshold height 15mm = 31mm total.

Calculation = FO Width: Less leaf widths = 64mm total.  
**PRO Therma** FO Height: Less slam strip 16mm less threshold height 35mm = 51mm total.

All sizes exclude fitting tolerances and these should be assessed on site depending on the application, a recommendation is 8-10mm per side.

Widths for side hinged doors are adjustable depending on the opening position of the door leaf, the drive through can be increased or decreased depending on the final fixing position and the installer should assess the installation as claims after installation will not be accepted.

### Classic Hinge Detail

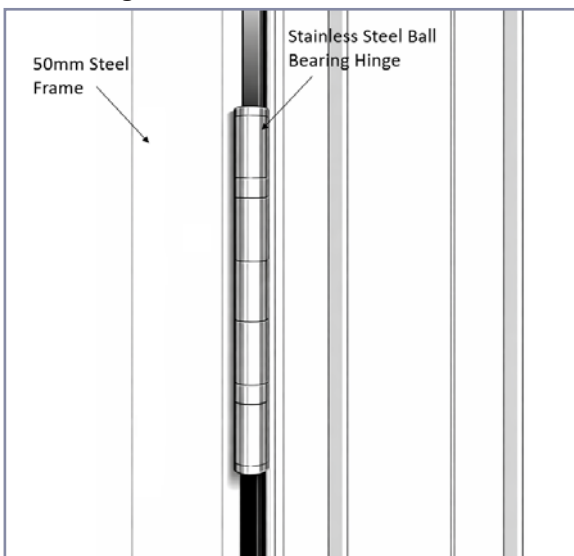

### Pro & Pro 20 Hinge and Threshold Detail

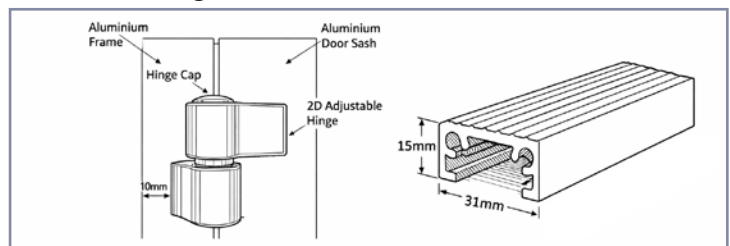

### Pro Therma Hinge and Threshold Detail

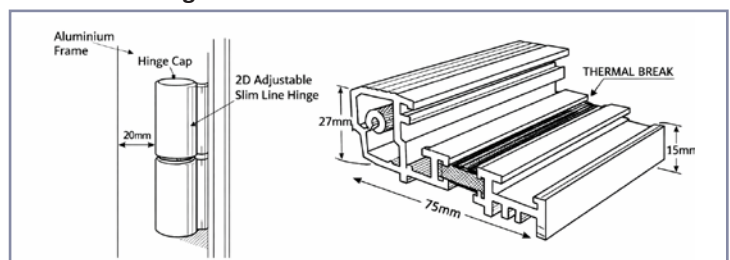



## Pro Therma Insulated Side Hinged Range

Who uses their garage to park a car anymore?

Give your customers unbeatable thermal performance and security:

- Thermally broken door, frame and threshold, U value 1.4
- “Garage-Protect” security with 3-point hook locking as standard
- 3-star PAS 24 TS007 anti-snap security cylinder
- Cast lever handle set and ERA Protect smart lock option

Presented by:

June 2026



Fort Doors, Unit 19, The Fort Industrial Park,  
Dunlop Way, Birmingham B35 7AR

tel: 0121 749 3699  
e-mail: [sales@fortdoors.co.uk](mailto:sales@fortdoors.co.uk)  
web: [fortdoors.co.uk](http://fortdoors.co.uk)

Fort Doors reserves the right to alter specification to design and manufacture without notification. All specifications are correct at the time of publication, errors and omissions are accepted. Due to the print/reproduction process all items are intended as a guide only. Colour samples are intended as a guide and samples are available from your dealer.